

Field Guide

F3 Compact Mine Detector

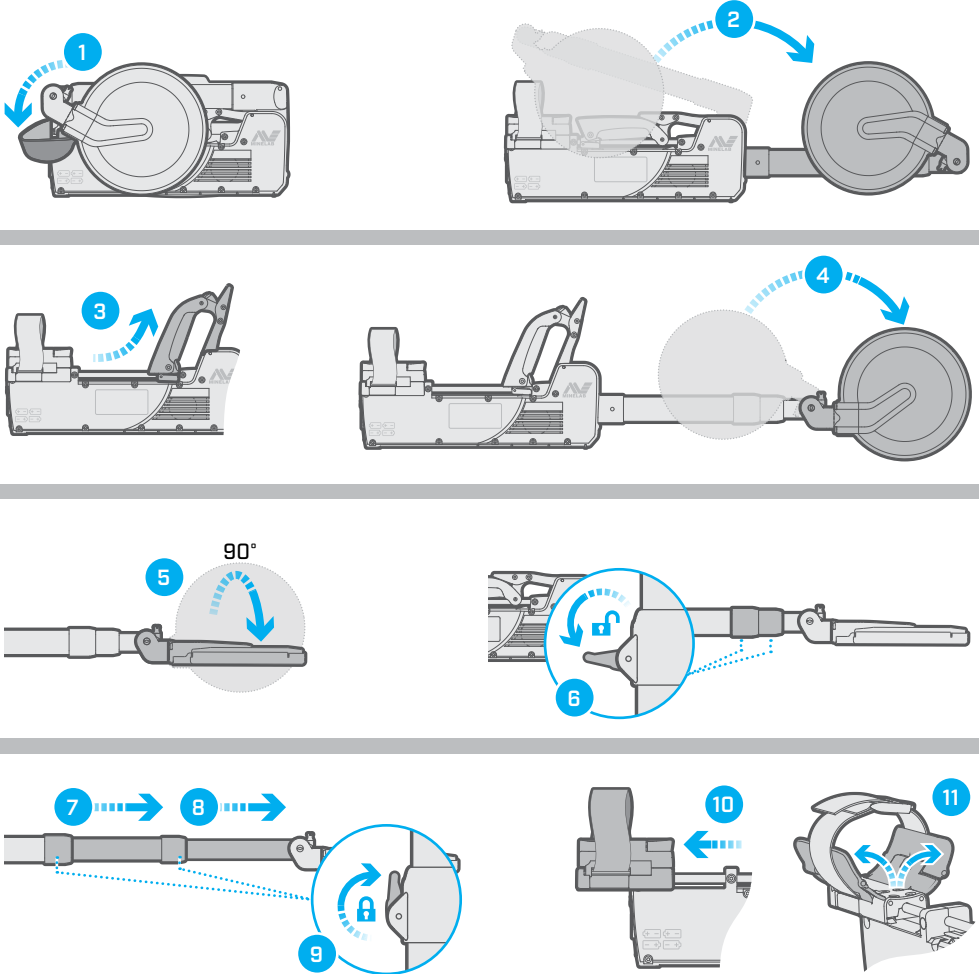

Unfolding Procedure



Pack Up

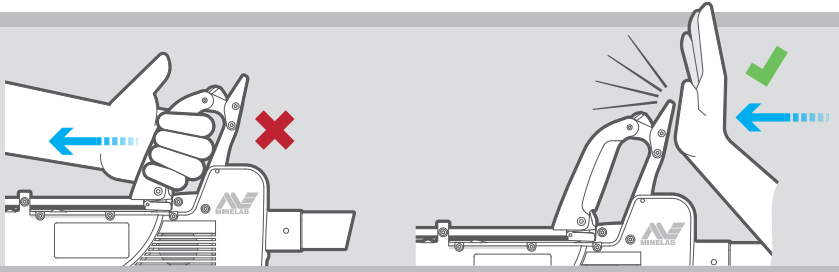

1. Switch On

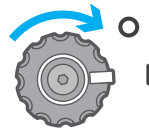
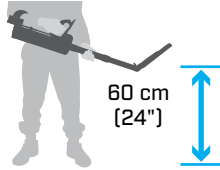
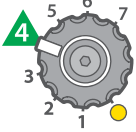

2. Ground Balance

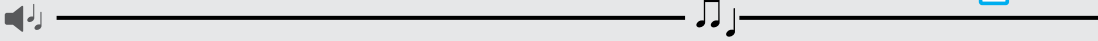
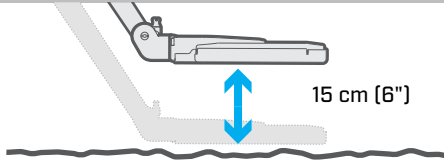

3. Test Piece

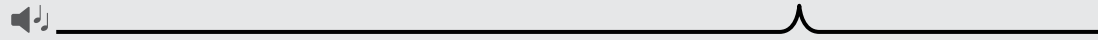
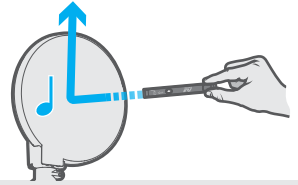
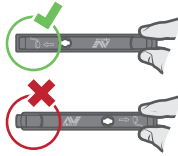
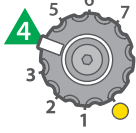

4. Audio Reset



5. Noise Cancel

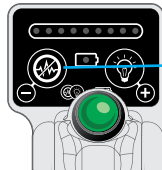
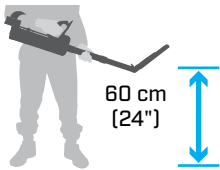
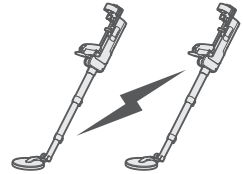
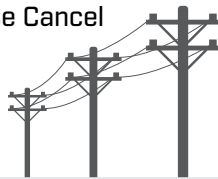

Hold for 2 seconds



Volume Control

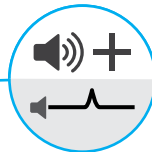
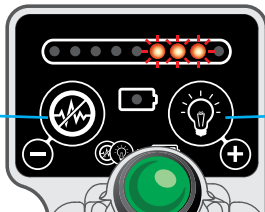
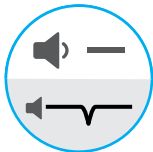

Default Setting

